

DIGGER XL

olly...XL

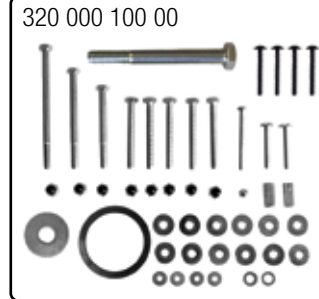
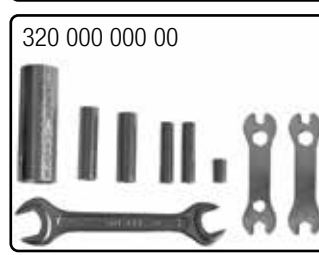
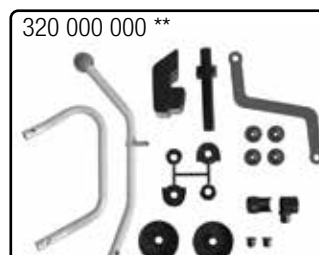
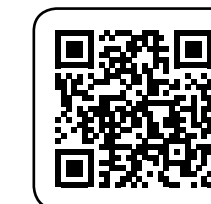

⚠️ AVERTISSEMENT

- RISQUE D'ÉTOUFFEMENT - Petites pièces. Ne convient pas aux enfants de moins de 3 ans.
- Doit être assemblé par un adulte.
- Surveillance d'un adulte est requise.
- Si le jouet est défectueux, cessez de l'utiliser. Toute réparation ne doit être effectuée que par un adulte.
- Ne jamais utiliser à proximité des marches, des pentes, des allées,
- des collines, des routes, des allées ou des piscines.
- Portez toujours des chaussures.
- Ne permettez jamais la présence de plus d'un coureur.
- L'utilisation d'un équipement de protection et d'un casque de sécurité est fortement recommandée.
- Les autocollants ne doivent être appliqués que par des adultes.
- Conforme aux exigences de la norme internationale ASTM Standard Consumer Safety Specification on Toy Safety, F 963.

⚠️ WARNING

- CHOKING HAZARD - Small parts. Not for children under 3 years.
- Must be assembled by adults.
- Adult supervision required.
- If toy is defective stop using it, repairs may only be carried out by adults.
- Never use near steps, slopes, driveways, hills, roadways, alleys or swimming pool areas.
- Always wear shoes.
- Never allow more than one rider.
- The use of protective gear and a safety helmet is highly recommended.
- The stickers are to be applied by adults only.
- Conforms to the requirements of ASTM Standard Consumer Safety Specification on Toy Safety, F 963.

⚠️ WARNING:

CHOKING HAZARD – Small parts.
Not for children under 3 years.

320 000 000 00

A 1x

28x2,5x84

B 1x

14x1,4x54

C 1x

14x1,4x50

D 2x

10x1,2x44

E 1x

10x1,5x17

---NORTH & SOUTH AMERICA only---

180 days warranty

From the date of purchase + guaranteed spare part service
The warranty does not cover damages caused by improper use or neglect



For questions, please call our North American Distributor
Kettler® international Inc.
phone: 888.253.8853
fax: 888.222.9333
email: toys@kettlerusa.com



- **
- +10
- +12
- +13
- +20
- +33
- +38
- +41
- +75
- +76
- +78
- +80

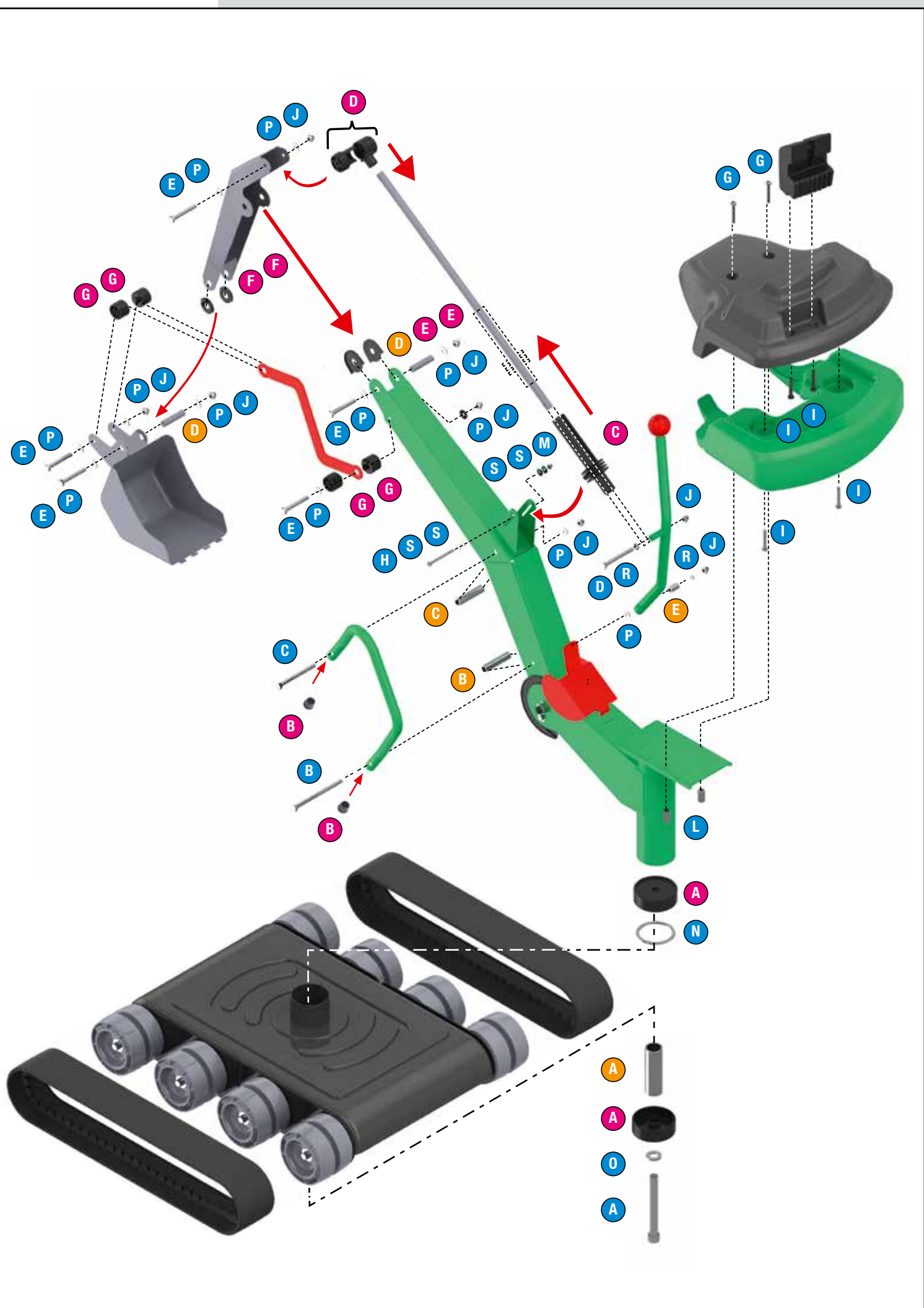
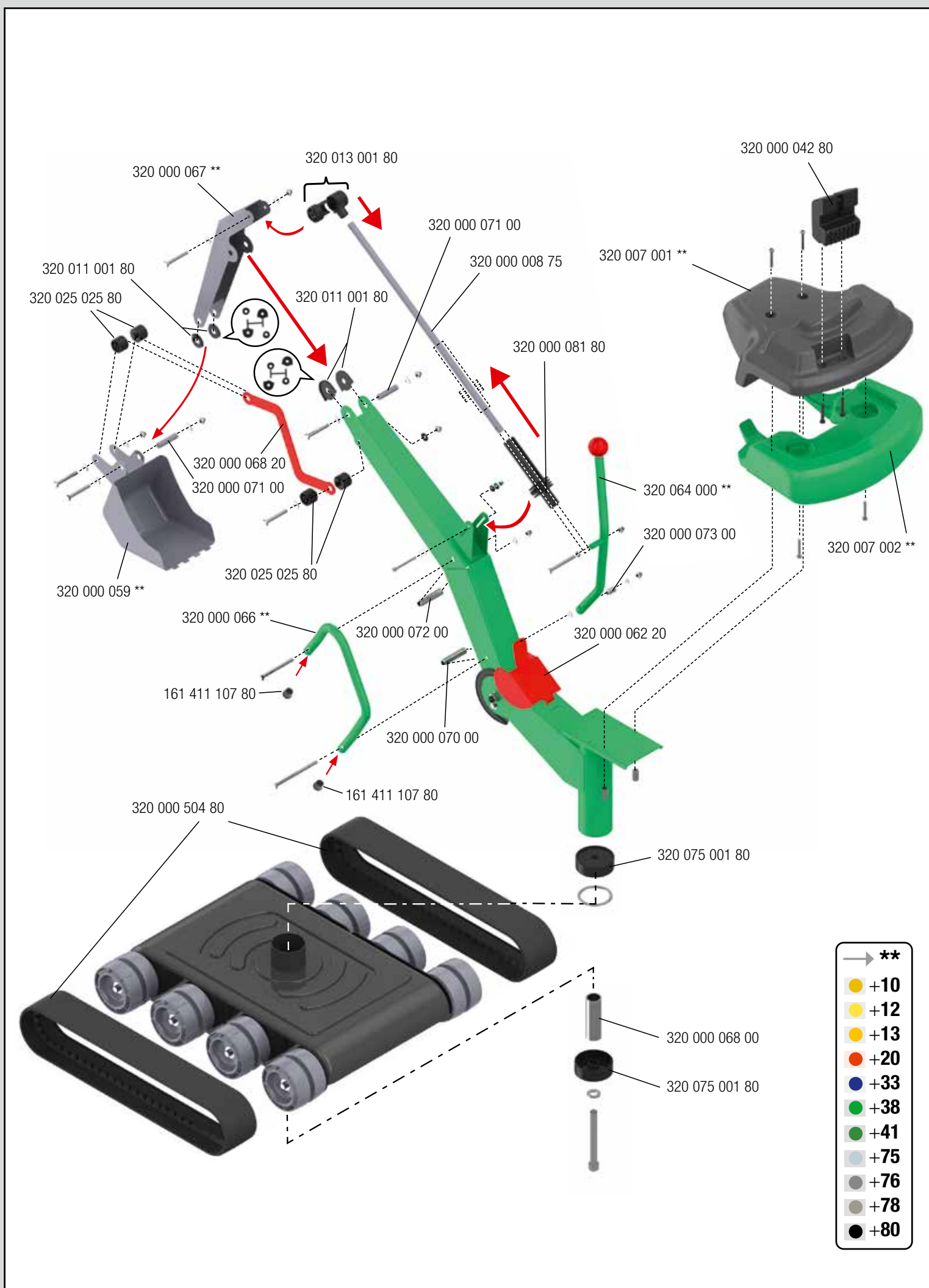

Rolly Toys Italiana S.R.L.
Via Colonna 9
I-31025 St. Lucia di Piave
made in Italy

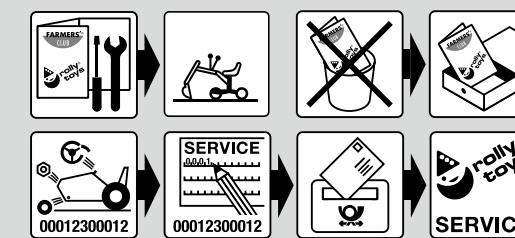

Franz Schneider GmbH & Co KG
Siemensstr. 13-19
D-96465 - Neustadt bei Coburg - Germany
Tel.: +49 (0) 95 68 / 856-0
Fax.: +49 (0) 95 68 / 856-190
www.rollytoys.com - e-mail: service@rollytoys.de

